

TOTAL

One-Stop Tools Station

TOTAL

BATTERY LED FLOODLIGHT

TFLI2002



P20S



20V

Security instructions



Caution

Please read the operating instructions carefully and observe the notes provided. Save the instructions for future reference.



Use the instructions to familiarize yourself with the product, its proper use and the safety notes. Safe operation of this machine is only possible when the operating or safety information is fully read and the instructions contained therein are strictly followed.

When using power tools, basic safety precautions should always be followed to reduce the risk of fire, electric shock, and personal injury, including the following:

Product Safety Instructions



Caution

Read, understand and follow all safety rules and operating instructions in this manual before using this product.

Be sure to read and understand all instructions in this manual before using this battery-powered spotlight. Failure to follow all instructions may result in electrical shock, fire, and/or serious personal injury.







- Learn about its applications and limitations, as well as the specific potential hazards associated with this tool.
- Use only the recommended battery pack and charging cradle. Any attempt to use another battery pack will result in explosion, fire, or personal injury.
- Remove the battery pack from the LED spotlight before replacing the bulb or performing any routine maintenance or cleaning.
- Allow the LED work spotlight to cool down for several minutes after use before changing the bulb.
- Do not disassemble the tool or the battery.
- Do not place the spotlight and battery pack near fire or heat. They can explode. Also, do not dispose of a spent battery pack by incineration, even if it is severely damaged or completely worn out. The battery can explode in flames.
- Do not use the work light or charging stand near flammable liquids or in gaseous or explosive atmospheres. Internal sparks can cause flames.
- To reduce the risk of electric shock, do not put the tool in water or other liquid. Do not place or store the portable spotlight where it can fall or be pulled into a container of water.
- Do not allow children to use tools without supervision. It's not a toy. The temperature of the bulb will warm up after being on after a period of time. This hot temperature can cause burns if touched.
- Do not use or allow the use of this tool in bed or sleeping bags. This handheld LED spotlight can melt fabric and cause a burn injury.
- Keep the light dry, clean and free of oil or grease. Always use a clean cloth when cleaning. Never use brake fluid, gasoline, petroleum-based products, or any strong solvents to clean the LED spotlight.

Battery Safety Warnings

Read all warnings and safety instructions. Failure to follow the warnings and instructions may result in electric shock, fire, and/or serious injury.

- Risk of fire and burns. Do not disassemble, heat above 100°C (212°F), or incinerate. Do not expose cells or batteries to heat or fire. Avoid storage in direct sunlight.
- Dispose of the used battery properly. When disposing of used cells or batteries, keep cells or batteries of different electrochemical systems separate.
- Keep the battery out of the reach of children and in the original package until ready to use.
- The battery used in this device may present a risk of fire or chemical burn if not treated properly. Replace the battery with original replacement parts approved by the manufacturer. Use of another battery may present a risk of fire or explosion.
- Do not use a visibly damaged battery pack or device.
- Do not modify or attempt to repair the device or the battery pack, as applicable.
- Do not short circuit a cell or battery. Do not store cells or batteries haphazardly in a box or drawer where they can short-circuit each other or be short-circuited by conductive materials.
- Do not subject cells or batteries to mechanical shock.
- Keep cells and batteries clean and dry. Wipe the cell or battery terminals with a clean, dry cloth if they become dirty.
- Do not use any charger other than the one specifically provided for use with the equipment. Batteries must be charged before use. Always use the correct charger and refer to the manufacturer's instructions or equipment manual for proper charging instructions.
- Whenever possible, remove the battery from the equipment when not in use.
- Avoid accidental ignition. Make sure the switch is in the off position before connecting the battery pack, picking up or carrying the tool.
- Disconnect battery pack from spotlight before making adjustments, changing accessories, or storing. These preventative safety measures reduce the risk of the tool being started accidentally.
- Under abusive conditions, fluid can be expelled from the battery; avoid contact. If accidental contact occurs, rinse with water. If the liquid comes into contact with the eyes, also seek medical help. Liquid expelled from the battery can cause irritation or burns.
- Have a Total technician perform service using only identical replacement parts. This will ensure that product safety is maintained.

Symbols

	To reduce the risk of injury, the user must read the instruction manual
	Do not expose to rain or water.
	Do not burn
	Lithium Ion Battery, the battery must be recycled properly and must be sorted for environmentally friendly recycling.
	Class III
	Do not stare at the operating light source

Technical data

Data sheet	
Voltage	20V
charger voltage	100-240V ~ 50/60Hz
low level lumens	750
high level lumens	1500

*The tool is designed for use with Total's P20S range of batteries and chargers.

Note: Due to the continuous program of R&D&I, this document is subject to change without notice.

Product description



1. Handlebar/handle cover
2. Handlebar / handle
3. Adjustment wheel
4. Hook

5. Support pad
6. Supports
7. Front cover
8. On/off switch

Operating instructions

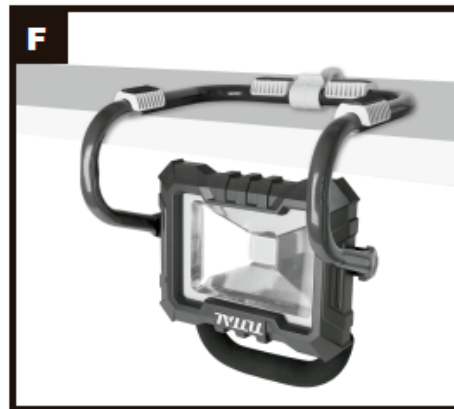
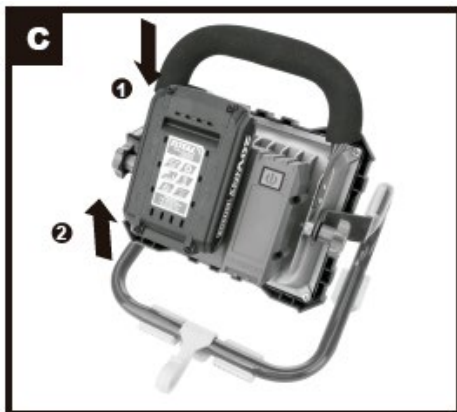
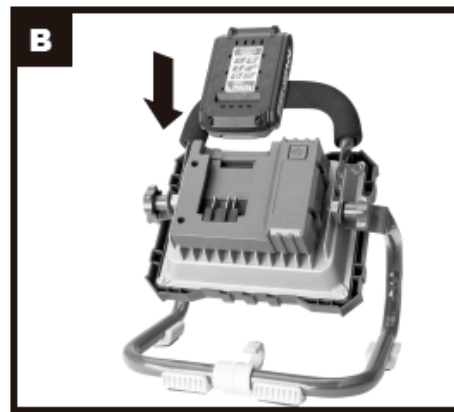

Note: Before using the tool, please read the instruction book carefully.

Figure	Action
Before the operation	
Figure A	Battery charge
Figure B	Battery Installation
Figure C	Battery removal
Set up	
Figure D	Start and stop: <u>To turn on low beam:</u> Press the on/off switch <u>To stop your high light:</u> Press the on/off switch twice Warning: Do not direct the light beam at the eyes.
Reflector Placement	
Caution: Be sure to position the tool well to avoid the risk of falling.	
Figure E	Use of the hook to hang the LED spotlight: Warning: Do not hang the work light from any electrical power cables.
Figure F	Using the bracket to hang the light
Adjustable lighting angle	
Figure G	The searchlight head can be configured in a variety of positions. To change base positions, turn the adjusting wheel to loosen the reflector. Adjust the light to the desired position, tighten the adjustment wheel. Caution: Do not put your hands or fingers between the adjustable head and the bracket when setting up the work light to avoid any danger.



Maintenance Tips

Replace any part or accessory with original manufacturer-approved replacement parts. See the accessory packaging for details. The store staff can help you and offer advice.

Environment



- Do not dispose of electrical appliances as unsorted municipal waste, use separate collection facilities.
- Contact your local authority for information on available collection systems.
- If electrical appliances are disposed of in landfills, hazardous substances can seep into the groundwater and enter the food chain, harming your health and well-being.
- Recycle raw materials instead of disposing of them as waste.
- The machine, accessories and packaging must be sorted for environmentally friendly recycling.

TOTAL

One-Stop Tools Station

TOTAL

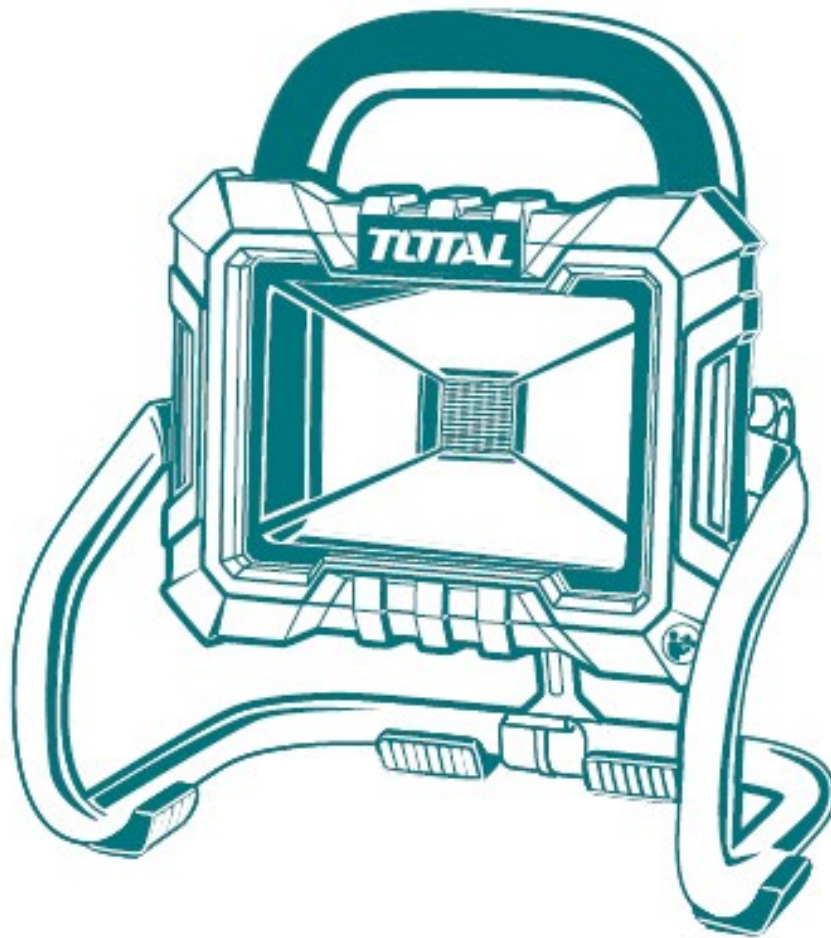

BATTERY LED FLOODLIGHT

20V